

# PRODUCTS & SOLUTIONS

---







# 4D BARN RUBBER





# THE GOLDEN STANDARD IN DURABILITY AND COMFORT



Special designed grooved top for extra traction. Can be used with Alleyvac, automatic scrapers, skidsteers and flush. Resistant to abrasion, giving cows the confidence to perform!



**ON ROLLS, EASY APPLICATION**



**PATTERNS AVAILABLE**



## SPECIFICATIONS

Thickness	1" - 1¼"
Dimensions	Large variety of widths and lengths. Custom cut to fit your application.





# 4D GIANT HEADLOCKS



4-D Ag giant headlocks are designed for the commercial dairy industry. One of the heaviest built in the dairy industry. The entire panel is hot dipped galvanized after welding and fabrication. Each of the panels has a solid connecting rod on top, and solid hardened bushings through the pivot arms. This results in longevity of the headlocks. The headlock opening is one of the widest in the industry, which allows greater feeding area.





# HOT DIPPED GALVANIZED



4-D Ag has headlocks for cows and heifers.



EFFECTIVE  
DESIGN

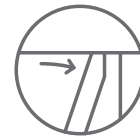

PIVOTING BAR  
ALWAYS FALLS OPEN



## SPECIFICATIONS

Width

8' - 10' - 12'

Openings

5 hole in 10'  
6 hole in 10', cows & heifers

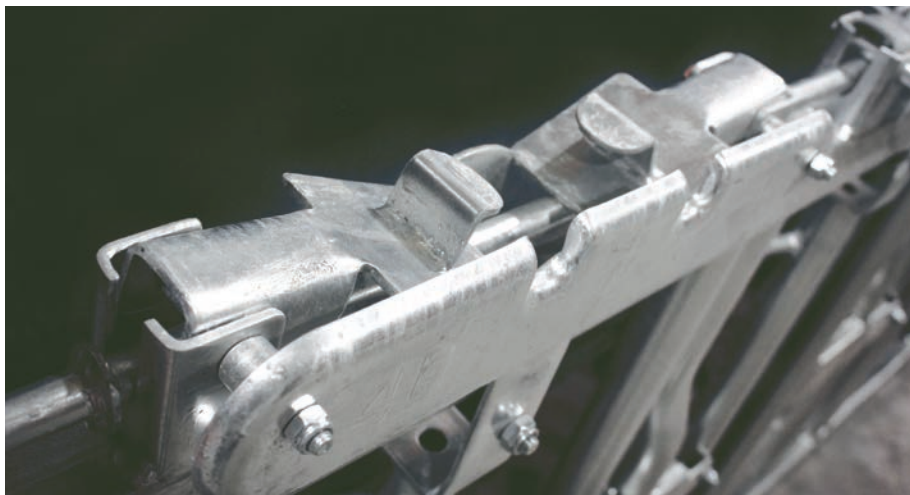



# 4D HS HEADLOCKS



**4-D HS Headlocks are available in:**

5-10' cows

6 in 10' cows

6 in 10' heifers

7 in 10' heifers

Proven concept for a very attractive price!







# 4D ARCHED HEADLOCKS

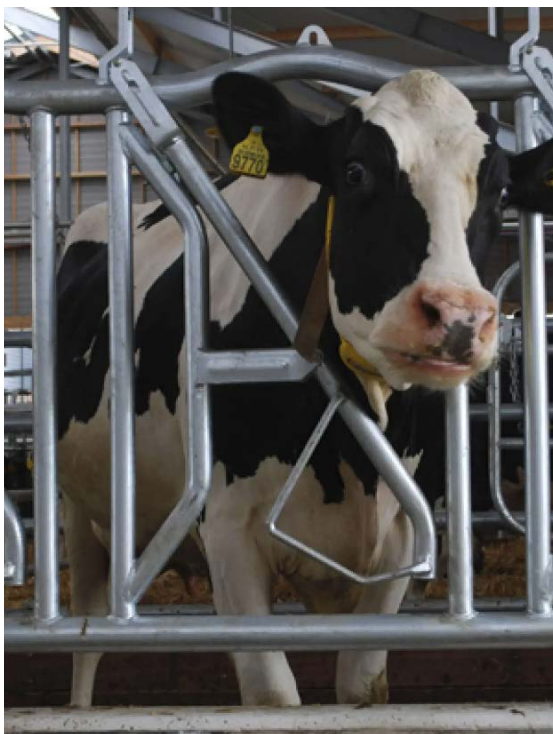

## Simplicity and functionality

The ultimate in Headlock solutions, the Arched headlock provides an exceptionally wide top opening and a curved rail that minimizes contact with the cow's head. Arched headlocks have an 18 3/4" curved opening across the top and all the standard features offered with all our self locks, making handling cows, easy, fast stress free occasion.

Features of the Arched Headlocks:

- Cow friendly design
- Simplicity and functionality
- Large 18 3/4" head opening and curved top rail
- Cows can be locked individually with a locking pin.
- Quiet operation
- Low maintenance; Hot dipped galvanized.





# 4D ECONOMY HEADLOCKS



## Features

Our Economy style headlocks have heavier pivot point, and heavy-duty bushings compared to many other products on the market. Noise-reducing hardware helps to prolong life with no steel-on-steel wear and tear. With quick release mechanisms, good head and neck spacing, our Economy style headlock system is designed with cow comfort at the top of mind.

- Panic release
- Bottom blocker
- Pro-pole release
- Visual locking setting
- Available in 5, 6, 7, and openings per 10' panel
- Hot dip galvanized





# 4D STRAIGHT BAR FEED SAVOR



The Straight Bar feed savor is designed to replace the Feed rail neck pipe that has been proven over time to not be comfortable for cows. There is no cow discomfort at the neck of the cow with this design.



The Straight bar feed savor, is eliminating cow behavior going left and right avoiding bossy cows to control a large area, spilling feed during that process, there is a 1-2% feed saving possible.

Custom design are available on request.

# 4D YOUNGSTOCK

The picture is a 6 in 10' 6 1/2" neck opening, 7 in 10' 5 3/4" neck opening 32" tall.



Angle training panel

10 in 10'

11 in 10'



Angle training panel

10 in 10'

32" Tall

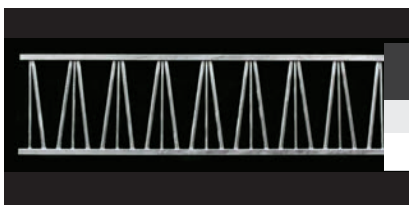

V-shape training panel

8 in 10'

32" Tall



4-D HS heifer headlock

6 in 10'

32" Tall









# 4D HOUSING SOLUTIONS



Freestall dividers are custom built to fit your individual facility needs. Clamps are hot dipped galvanized, and made of thick steel to provide a lasting solution.

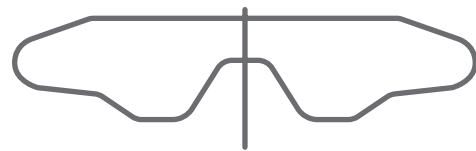

Multipurpose Plus loop



Multipurpose loop

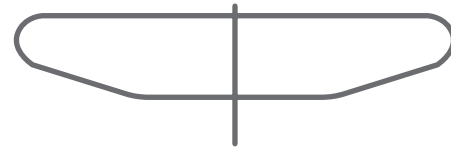

Basic loop



Pasture loop



Vertical post mounting



## SPECIFICATIONS

Sizes

Custom sizing available

Shapes

Custom shapes available





# 4D AIR COOLING SOLUTIONS







Copied by American and Chinese companies alike, the original MagFan, first launched in 2014, remains the world leader in fan efficiency. The strong double wall housing provides extreme stability and 4mm (8 ga.) stainless motor brackets hold the center mounted, slim and aerodynamic European made permanent magnet motor firmly in place. The optional MagDoor ensures a completely airtight seal when the fan is not running.

The MagFan is designed to operate in the full range from a minimum of 160 rpm to the maximum output at 750/860 rpm, depending on impeller pitch and blade solidity. The motor drive takes a simple 0-10V signal. With its high performance, unmatched efficiency and extreme reliability, MagFan is the most economical choice both short and long term.

### Cone

- 8 sections for reduced shipping and easy installation
- Deep cone increases performance and reduces light and water ingress
- Rugged, corrosion resistant UV stabilized poly
- Gray color virgin material reflects heat twice as good as black
- Heat stabilized to withstand temperatures of 120°C/248°F

### Housing

- Injection molded impact resistant high-grade plastics with UV inhibitors
- Gray color virgin material reflects heat twice as good as black
- Heat stabilized to withstand temperatures of 120°C/248°F
- 100% corrosion resistant

### Impeller

- Balanced, precision injection molded glass filled PP composite blades
- Poly/precision milled aluminum hub with integrated taper lock
- No tolerance issues and no risk to motor during installation
- Effortless installation with extreme clamping force
- Market leading efficiency and durability

### MagDoor Roller door (option)

- A completely airtight, insulated seal
- Withstands 250Pa / 1" static pressure
- Corrosion resistant anodized aluminum and PVC
- Seals from the inside – no broken baffles or spring failures
- Extremely low power consumption – can run on UPS/Solar

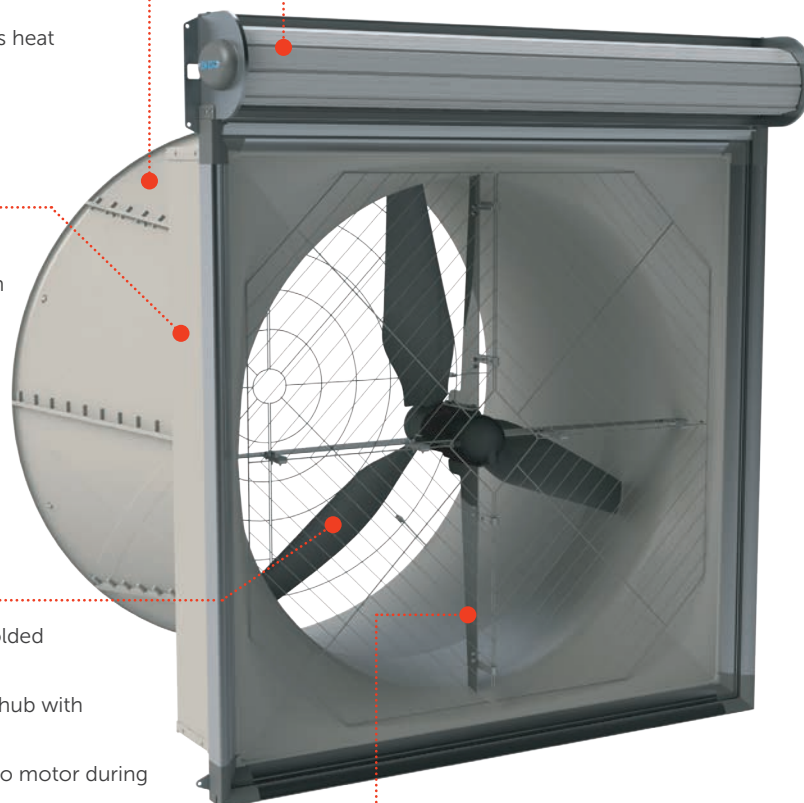

### Motor brackets and guards

- Corrosion resistant stainless steel 304



# 4D CYCLONE FAN

## Housing

- Made with durable, and corrosion-free reinforcement fiber composite
- Directional air deflectors with a wide range of angle

## Impeller

- Heavy-duty and high precision bearing assembly with double protection seal
- Shaft fixed on a quick base mount
- Belt will go over fan blades if needed to be replaced.
- Aluminum comes standard on belt drive fans and Nylon comes standard for direct drive fans

## Options

- 1 or 3 phase motor
- Variable frequency drive (VFD)
- Belt driven and direct drive

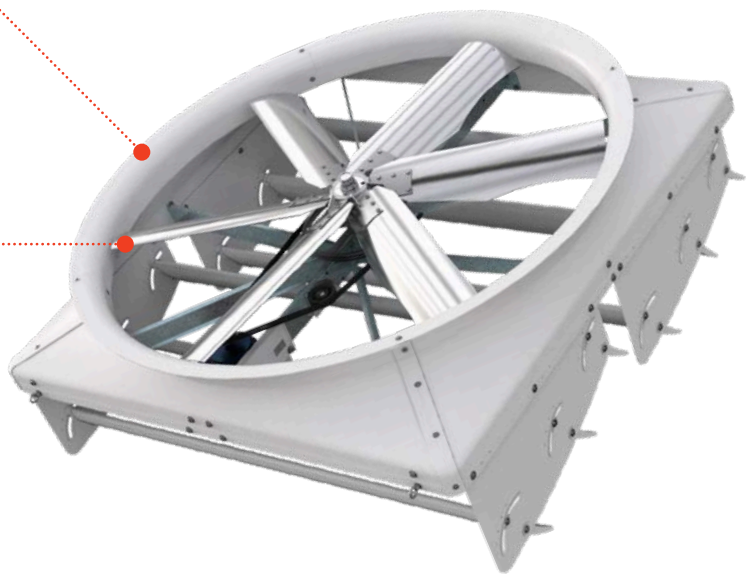

## PRODUCT RANGE

Cyclone

55" - 72" - 84"





# 4D COMFY MAT

- Surface designed for good grip not abrasive
- Great alternative for Dairies farms that switch to digesters
- 1 1/2" thick rubber mats
- Rubber Rolls different lengths available.
- Integrated slope to keep Comfy mat dry.
- Cushion pattern on bottom side.
- DLG Tested.
- Easy to install.





# 4D HOLLOW RING MAT



A hybrid mat suitable for indoor and outdoor applications, excellent for walking and standing.

- Heavy Duty
- mat size 59"x 39"x 1"
- Available in mat or roll form
- studded bottom for draining water and dirt.
- Hollow-ring corner connectors available.
- Made from Natural and Recycled rubber.

## INTERLOCKING TILES



Interlocking rubber tiles for milk parlors, safe sports flooring, and indoor stadium flooring.

- Comfortable and safe footing.
- Extremely durable.
- Interlock mats size 45" x 30 1/2" 3/4" thick.
- Corner interlock edge and Beveled taper interlock edge available.
- Made from Natural and Recycled Rubber.





# 4D COOL COW MATTRESS

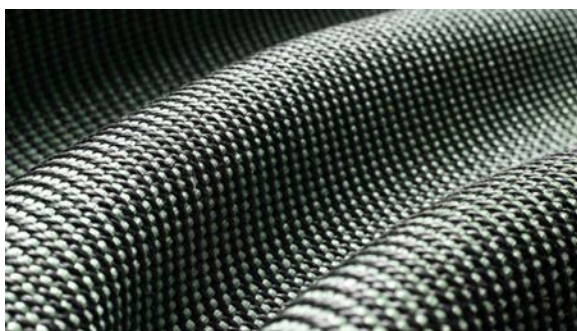
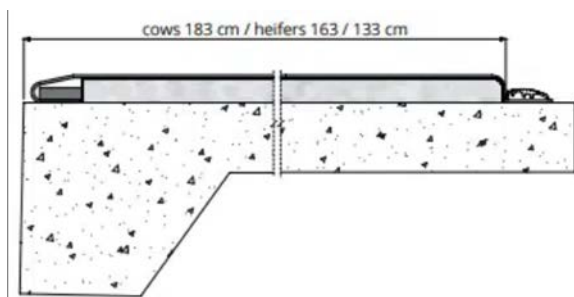

4D Cool cow mattress are created from polyurethane foam, latex or a combination of both, a protective plastic film, guaranteeing a waterproof foam layer. A strong top cover with rubber coating ensures many years of trouble free use.

Our foam helps maximize animal livelihood with its superior cushioning properties, with minimal impact to the environment.

- Helps increase overall comfort and relaxation levels
- Relieves stress on joints
- Decreases manual labor with less additional bedding
- Increased cost-savings on bedding materials over the long term due to longevity and durability



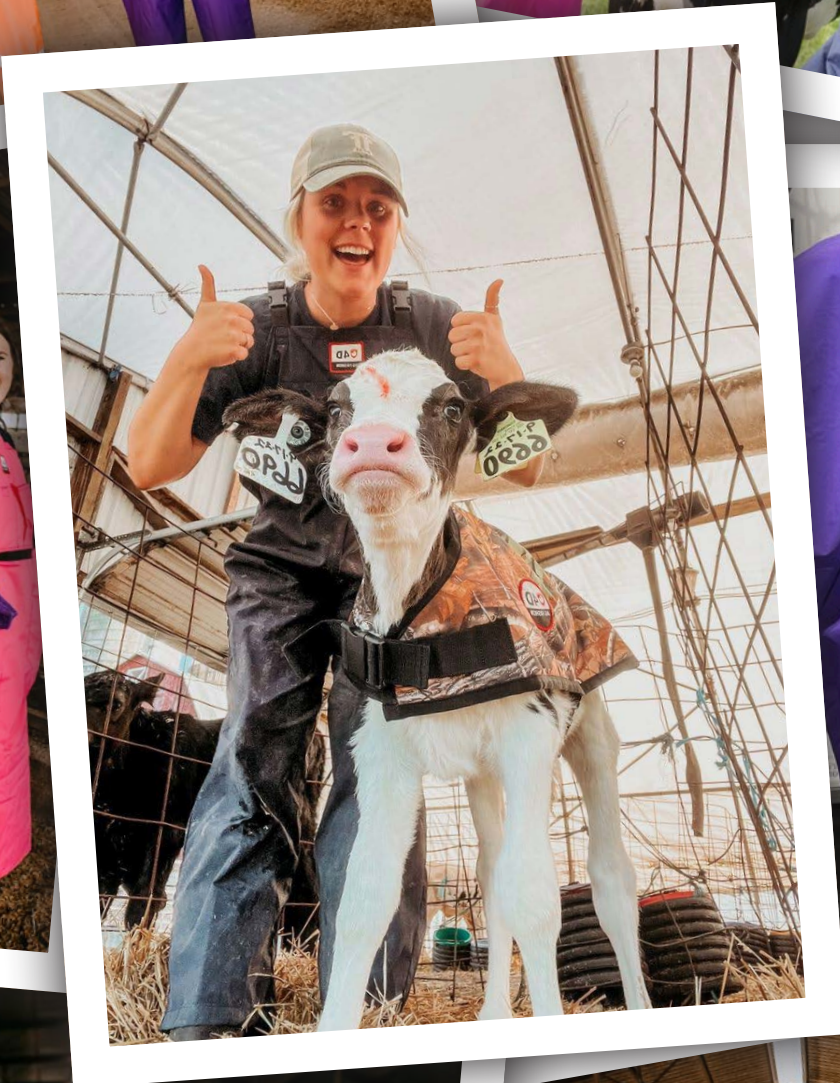





# HIGH QUALITY AFFORDABLE AGRICULTURE FASHION

With our sister company 4-D Ag Fashion we offer a full line of farm clothing for adults and kids.

We are very big in manufacturing calf jackets and also wholesale! Check out our webshop for high quality, cost effective farm clothing made in house!

- 🌐 [www.4dagfashion.com](http://www.4dagfashion.com)
- ✉ [orders@4dagfashion.com](mailto:orders@4dagfashion.com)
- ☎ 806-557-8406

### Wholesale/custom made orders

- ✉ [elizabeth@4dagfashion.com](mailto:elizabeth@4dagfashion.com)
- ☎ 806-656-1646







🌐 [www.4dagworld.com](http://www.4dagworld.com)

🌐 [www.4dagfashion.com](http://www.4dagfashion.com)

📞 806-557-8406

**Jan Pieter de Vries**

📞 806-443-3565

✉ [jp@4dagworld.com](mailto:jp@4dagworld.com)

**Elizabeth de Vries-Dykstra**

📞 806-656-1646

✉ [elizabeth@4dagfashion.com](mailto:elizabeth@4dagfashion.com)

**Bram de Vries**

📞 580-980-1893

✉ [bram@4dagworld.com](mailto:bram@4dagworld.com)